

The new KA series

TABLE OF CONTENTS

MAIN SWITCHES WITH EMERGENCY FUNCTION	6
Front mounting, 4-hole mounting	6
Front mounting, single-hole mounting 22mm	8
DIN rail mounting with simplified door clutches	9
DIN rail mounting with simplified door clutches and centering device	10
DIN rail mounting with door clutches	12
DIN rail mounting with simplified door clutches and centering device	13
MAINTENANCE SWITCHES	14
In plastic enclosure	14
In plastic enclosure (EMC)	16
SAFETY SWITCHES	17
In plastic enclosure in accordance with EN 2626-1 class 0	17
In plastic enclosure (EMC) in accordance with EN 2626-1 class 0	17
SWITCH DISCONNECTORS	18
Front mounting, 4-hole mounting	18
Front mounting, single-hole mounting 22mm	19
DIN rail mounting	19
DIN rail mounting, for 45 mm standard cutout	21
Plastic enclosure	22
CHANGEOVER SWITCHES	23
Front mounting, 4-hole mounting (Manual Transfer Switch)	23
DIN rail mounting	23
DIN rail mounting, for 45 mm standard cutout (Manual Transfer Switch)	24
In plastic enclosure (Manual Transfer Switch)	24
ADD-ON MODULES	25
TECHNICAL DATA	26

The KA Highlights

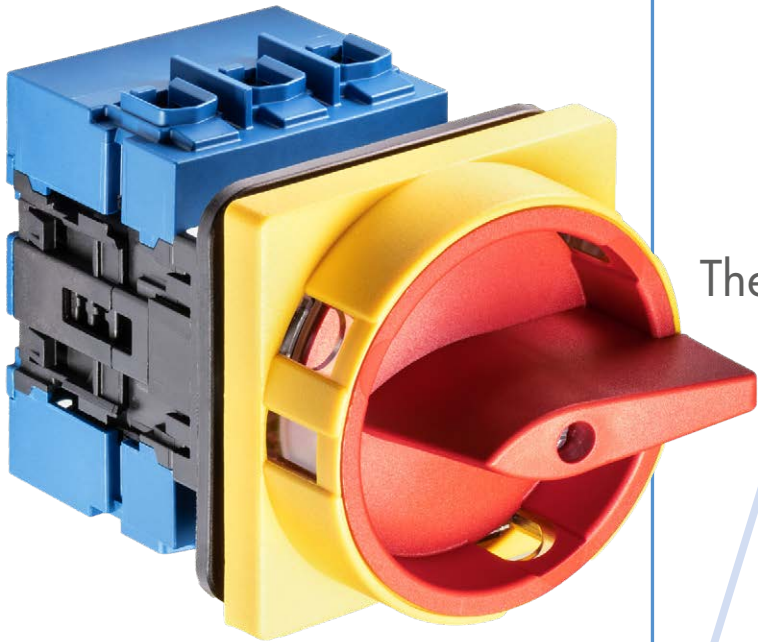

The new KA series



<p>3- to 8-pole on-off switches</p>	<p>3-pole and 4-pole Changeover switches</p>	<p>Cross recessed screws & Torx clamping screws</p>	<p>Conductor cross-section up to 25 mm²</p>
<p>single-hole mounting</p>	<p>4-hole mounting</p>	<p>DIN rail mounting</p>	<p>Enclosure installation</p>
			<p>RoHS ✓ REACH ✓</p>
<p>Through-type connector PE + N</p>	<p>Auxiliary contacts</p>	<p>Optional extras</p>	<p>ROHS & REACH compliant</p>

The new KA series – reliable & flexible

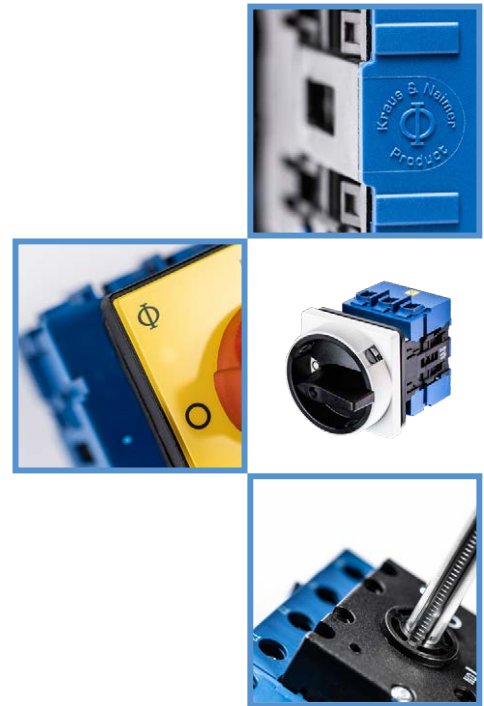

The new Kraus & Naimer **KA switch** series combines innovation and high quality standards and ensures reliable switching and disconnecting of circuits.

The KA switches are **extremely versatile** and can be used in **different applications**. They were specifically developed for machine tools, distribution cabinets and all applications that require a high degree of reliability.

The **exceptional Kraus & Naimer modular system** enables the implementation of different custom solutions. In this new switch series, as well as in all Kraus & Naimer products, **flexibility and top quality** are perfectly combined.

The **big terminal compartment** enables the connection of different electrical conductors with finger-safe IP20 terminals with a cross-section of up to 25 mm². The thermal rated current of the KA switches is between 40 and 63 A. **Cross recessed and Torx clamping screws** are available upon request.

Thanks to our global service network and our globally approved products that adhere to international standards, we are your partner of choice for control switches and switch disconnectors worldwide.

Kraus & Naimer
Blue Line Switchgear



Switch in plastic enclosure

MAIN SWITCHES WITH EMERGENCY FUNCTION

Dimensions in mm

Front mounting, 4-hole mounting

IP66/67

Locking device (F-handle)

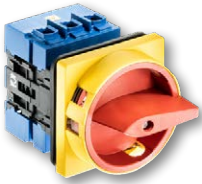

For 3 padlocks

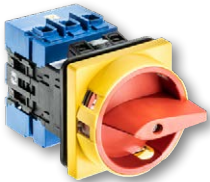
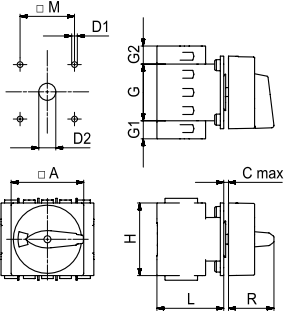
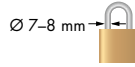

For 3 padlocks

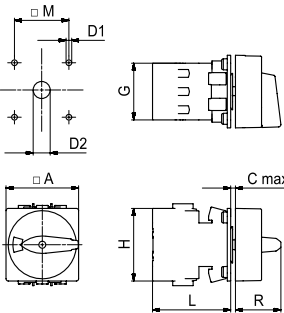
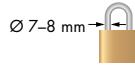

		Name	Art. no.		Name	Art. no.	
--	---	------	----------	---	------	----------	---

3-pole	KA40B.T203/01.E	70012701	KA40B.T103/01.E	70012699	+
	KA40BT.T203/01.E	70032755	KA40BT.T103/01.E	70032185	+
	KA63B.T203/01.E	70012705	KA63B.T103/01.E	70012703	+
	KA63BT.T203/01.E	70032651	KA63BT.T103/01.E	70032186	+

D1	D2	M	A	G	G1	G2	H	L	R	C _{max}
5	10-15	48	64	50	-	-	64	58,9	40	4

PE + N ¹ 3-pole	KA40B.T205/01.E	70031168	KA40B.T105/01.E	70026749	+
	KA40BT.T205/01.E	70032799	KA40BT.T105/01.E	70032816	+
	KA63B.T205/01.E	70031314	KA63B.T105/01.E	70031316	+
	KA63BT.T205/01.E	70033038	KA63BT.T105/01.E	70033018	+

D1	D2	M	A	G	G1	G2	H	L	R	C _{max}
5	10-15	48	64	50	16	16	64	58,9	40	4

		Name	Art. no.		Name	Art. no.	
--	---	------	----------	---	------	----------	---

With cam-controlled auxiliary contact 1x NO

3-pole	KA40B.T203/17.E	70031156	KA40B.T103/17.E	70031129	+
	KA40BT.T203/17.E	70032644	KA40BT.T103/17.E	70032200	+
	KA63B.T203/17.E	70031157	KA63B.T103/17.E	70031131	+
	KA63BT.T203/17.E	70032811	KA63BT.T103/17.E	70032201	+

D1	D2	M	A	G	H	L	R	C _{max}
5	10-15	48	64	50	64	68,9	40	4

With cam-controlled auxiliary contacts 1x NO/1x NC

3-pole	KA40B.T203/A1.E	70024382	KA40B.T103/A1.E	70024381	+
	KA40BT.T203/A1.E	70032777	KA40BT.T103/A1.E	70032748	+
	KA63B.T203/A1.E	70024384	KA63B.T103/A1.E	70024383	+
	KA63BT.T203/A1.E	70032818	KA63BT.T103/A1.E	70032679	+

D1	D2	M	A	G	H	L	R	C _{max}
5	10-15	48	64	50	64	68,9	40	4

Locking device



For 2 padlocks

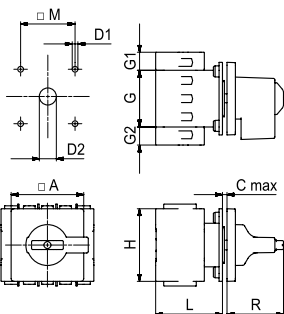
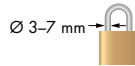

		Name	Art. no.		Name	Art. no.	
--	---	------	----------	---	------	----------	---

3-pole	KA40.T203/04.E	70022731	KA40.T103/04.E	70022730	+
	KA40T.T203/04.E	70032681	KA40T.T103/04.E	70032187	+
	KA63.T203/04.E	70031153	KA63.T103/04.E	70031127	+
	KA63T.T203/04.E	70032654	KA63T.T103/04.E	70032188	+

D1	D2	M	A	G	G1	G2	H	L	R	C _{max}
5	10-15	36	48	50	-	-	64	58,9	42,4	4

4-pole	KA40.T204/04.E	70031163	KA40.T104/04.E	70031137	+
	KA40T.T204/04.E	70032772	KA40T.T104/04.E	70032645	+
	KA63.T204/04.E	70026750	KA63.T104/04.E	70031138	+
	KA63T.T204/04.E	70032682	KA63T.T104/04.E	70032676	+

D1	D2	M	A	G	G1	G2	H	L	R	C _{max}
5	10-15	36	48	50	16	-	64	58,9	42,4	4

PE + N ¹ 3-pole	KA40.T205/04.E	70031938	KA40.T105/04.E	70031427	+
	KA40T.T205/04.E	70033007	KA40T.T105/04.E	70032804	+
	KA63.T205/04.E	70031944	KA63.T105/04.E	70031428	+
	KA63T.T205/04.E	70033045	KA63T.T105/04.E	70033026	+

D1	D2	M	A	G	G1	G2	H	L	R	C _{max}
5	10-15	36	48	50	16	16	64	58,9	42,4	4

¹ Through-type connector

Front mounting, 4-hole mounting

IP67

Locking device



For 3 padlocks

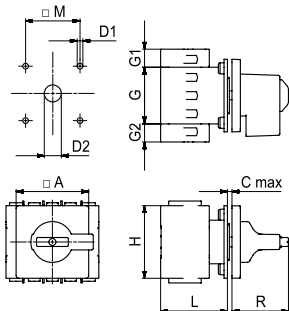
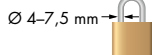

For 2 padlocks

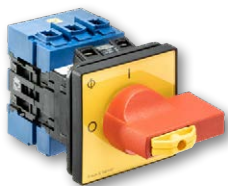
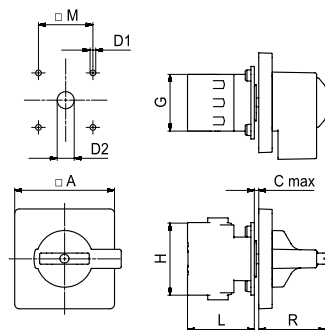
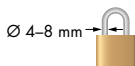

For 3 padlocks

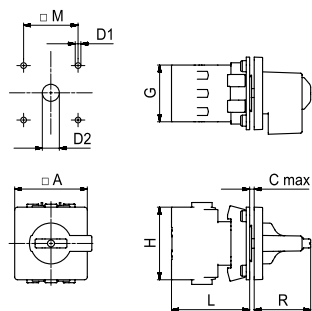
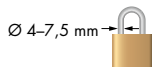

		Name	Art. no.		Name	Art. no.	
--	--	------	----------	--	------	----------	--

3-pole	KA40B.T203/04.E	70031154	KA40B.T103/04.E	70031128	+
	KA40BT.T203/04.E	70032685	KA40BT.T103/04.E	70032190	+
	KA63B.T203/04.E	70031155	KA63B.T103/04.E	70031104	+
	KA63BT.T203/04.E	70032780	KA63BT.T103/04.E	70032191	+

D1	D2	M	A	G	G1	G2	H	L	R	C _{max}
5	10-15	48	64	50	-	-	64	58,9	49,8	4

PE + N ¹ 3-pole	KA40B.T205/04.E	70031172	KA40B.T105/04.E	70031152	+
	KA40BT.T205/04.E	70032820	KA40BT.T105/04.E	70033006	+
	KA63B.T205/04.E	70031945	KA63B.T105/04.E	70031332	+
	KA63BT.T205/04.E	70033028	KA63BT.T105/04.E	70033013	+

D1	D2	M	A	G	G1	G2	H	L	R	C _{max}
5	10-15	48	64	50	16	16	64	58,9	49,8	4

		Name	Art. no.		Name	Art. no.	
--	--	------	----------	--	------	----------	--

3-pole	KA40B.T203/81.E	70031160	KA40B.T103/81.E	70031135	+
	KA40BT.T203/81.E	70032768	KA40BT.T103/81.E	70032628	+
	KA63B.T203/81.E	70031435	KA63B.T103/81.E	70031136	+
	KA63BT.T203/81.E	70032749	KA63BT.T103/81.E	70032759	+

D1	D2	M	A	G	H	L	R	C _{max}
5	10-15	48	88	50	64	58,9	59,2	4

		Name	Art. no.		Name	Art. no.	
--	--	------	----------	--	------	----------	--

With cam-controlled auxiliary contact 1x NO

3-pole	KA40B.T203/20.E	70031158	KA40B.T103/20.E	70031133	+
	KA40BT.T203/20.E	70032781	KA40BT.T103/20.E	70032486	+
	KA63B.T203/20.E	70031159	KA63B.T103/20.E	70024373	+
	KA63BT.T203/20.E	70032791	KA63BT.T103/20.E	70032487	+

D1	D2	M	A	G	H	L	R	C _{max}
5	10-15	48	64	50	64	68,9	49,8	4

With cam-controlled auxiliary contacts 1x NO/1x NC

3-pole	KA40B.T203/A2.E	70032554	KA40B.T103/A2.E	70032543	+
	KA40BT.T203/A2.E	70032750	KA40BT.T103/A2.E	70032667	+
	KA63B.T203/A2.E	70032555	KA63B.T103/A2.E	70032545	+
	KA63BT.T203/A2.E	70032660	KA63BT.T103/A2.E	70032686	+

D1	D2	M	A	G	H	L	R	C _{max}
5	10-15	48	64	50	64	68,9	49,8	4

¹ Through-type connector

MAIN SWITCHES WITH EMERGENCY FUNCTION

Dimensions in mm

Front mounting, single-hole mounting 22mm

IP66/67/69k

Locking device

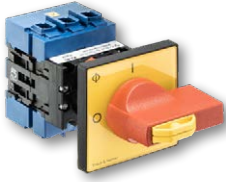

For 2 padlocks

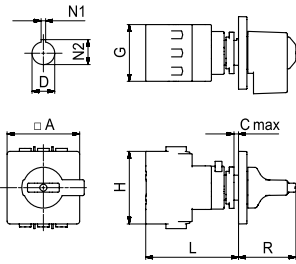
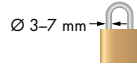

Name	Art. no.	Name	Art. no.
------	----------	------	----------

3-pole	KA40.T203/04.FH3	70032173	KA40.T103/04.FH3	70031917	+
	KA40.T203/04.FH3	70031935	KA40.T103/04.FH3	70032178	+
	KA63.T203/04.FH3	70032174	KA63.T103/04.FH3	70031928	+
	KA63.T203/04.FH3	70032180	KA63.T103/04.FH3	70032179	+

N1	N2	D	A	G	H	L	R	C max
3,2	24,1	22,3	64	50	64	81,8	50,6	4

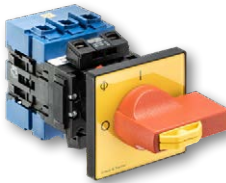

For 2 padlocks

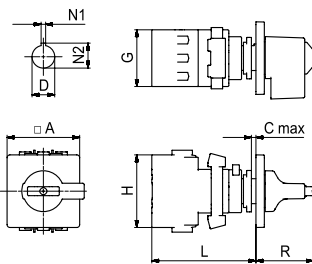
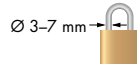

Name	Art. no.	Name	Art. no.
------	----------	------	----------

With cam-controlled auxiliary contacts 1x NO/1x NC

3-pole	KA40.T203/B4.FH3	70031245	KA40.T103/B4.FH3	70031237	+
	KA40.T203/B4.FH3	70031319	KA40.T103/B4.FH3	70031312	+
	KA63.T203/B4.FH3	70031242	KA63.T103/B4.FH3	70031251	+
	KA63.T203/B4.FH3	70031317	KA63.T103/B4.FH3	70031323	+

N1	N2	D	A	G	H	L	R	C max
3,2	24,1	22,3	64	50	64	91,8	50,6	4

DIN rail mounting with simplified door clutches

IP66/67/69k

Locking device, single-hole mounting 22 mm

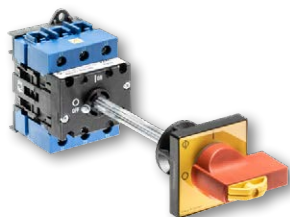

For 2 padlocks
 Ø 3-7 mm

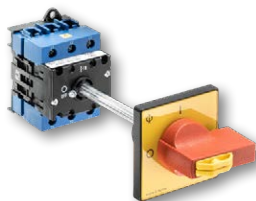
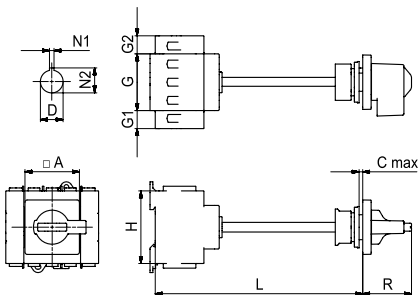

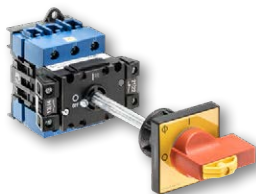
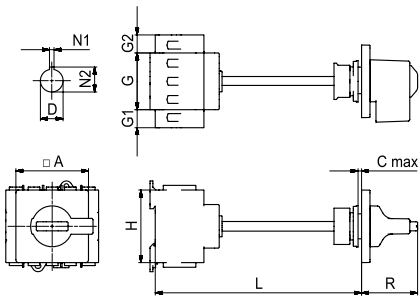

For 3 padlocks
 Ø 4-7,5 mm

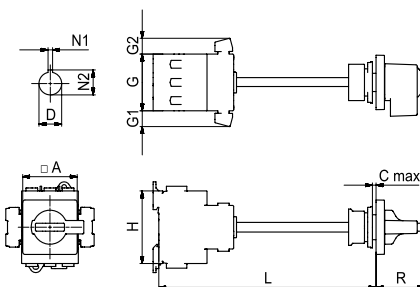

For 2 padlocks
 Ø 3-7 mm



		Name	Art. no.		Name	Art. no.	
--	---	------	----------	---	------	----------	---

3-pole	KA40.T203/68.VE	70031294	KA40.T103/68.VE	70031278	+
	KA40T.T203/68.VE	70032640	KA40T.T103/68.VE	70032574	+
	KA63.T203/68.VE	70031295	KA63.T103/68.VE	70031279	+
	KA63T.T203/68.VE	70032817	KA63T.T103/68.VE	70032575	+



N1	N2	D	A	G	G1	G2	H	L	R	C _{max}
3,2	24,1	22,3	48	50	-	-	64	165-185	43	4

4-pole	KA40.T204/68.VE	70031910	KA40.T104/68.VE	70031424	+
	KA40T.T204/68.VE	70033022	KA40T.T104/68.VE	70032680	+
	KA63.T204/68.VE	70031911	KA63.T104/68.VE	70031425	+
	KA63T.T204/68.VE	70032657	KA63T.T104/68.VE	70032664	+

N1	N2	D	A	G	G1	G2	H	L	R	C _{max}
3,2	24,1	22,3	48	50	16	-	64	165-185	43	4

PE+N ¹	KA40.T205/68.VE	70031930	KA40.T105/68.VE	70031296	+
	KA40T.T205/68.VE	70033005	KA40T.T105/68.VE	70033008	+
	KA63.T205/68.VE	70031931	KA63.T105/68.VE	70031396	+
	KA63T.T205/68.VE	70033017	KA63T.T105/68.VE	70033030	+

N1	N2	D	A	G	G1	G2	H	L	R	C _{max}
3,2	24,1	22,3	48	50	16	16	64	165-185	43	4

		Name	Art. no.		Name	Art. no.	
--	---	------	----------	---	------	----------	---

3-pole	KA40B.T203/68.VE	70031400	KA40B.T103/68.VE	70031379	+
	KA40BT.T203/68.VE	70033042	KA40BT.T103/68.VE	70032576	+
	KA63B.T203/68.VE	70031355	KA63B.T103/68.VE	70031381	+
	KA63BT.T203/68.VE	70032652	KA63BT.T103/68.VE	70032577	+

N1	N2	D	A	G	G1	G2	H	L	R	C _{max}
3,2	24,1	22,3	64	50	-	-	64	165-185	49,4	4

PE+N ¹	KA40B.T205/68.VE	70031933	KA40B.T105/68.VE	70031397	+
	KA40BT.T205/68.VE	70033036	KA40BT.T105/68.VE	70032653	+
	KA63B.T205/68.VE	70031934	KA63B.T105/68.VE	70031398	+
	KA63BT.T205/68.VE	70033023	KA63BT.T105/68.VE	70033025	+

N1	N2	D	A	G	G1	G2	H	L	R	C _{max}
3,2	24,1	22,3	64	50	16	16	64	165-185	49,4	4

		Name	Art. no.		Name	Art. no.	
--	---	------	----------	---	------	----------	---

With cam-controlled auxiliary contact 1x NO

3-pole	KA40.T203/72.VE	70031299	KA40.T103/72.VE	70031280	+
	KA40T.T203/72.VE	70032767	KA40T.T103/72.VE	70032666	+
	KA63.T203/72.VE	70031300	KA63.T103/72.VE	70031281	+
	KA63T.T203/72.VE	70032797	KA63T.T103/72.VE	70032675	+

N1	N2	D	A	G	G1	G2	H	L	R	C _{max}
3,2	24,1	22,3	48	50	14	-	64	170-195	43	4

With cam-controlled auxiliary contacts 1x NO/1x NC

3-pole	KA40.T203/A5.VE	70032556	KA40.T103/A5.VE	70032546	+
	KA40T.T203/A5.VE	70033014	KA40T.T103/A5.VE	70032756	+
	KA63.T203/A5.VE	70032559	KA63.T103/A5.VE	70032547	+
	KA63T.T203/A5.VE	70033003	KA63T.T103/A5.VE	70032633	+

N1	N2	D	A	G	G1	G2	H	L	R	C _{max}
3,2	24,1	22,3	48	50	14	14	64	170-195	43	4

¹ Through-type connector

MAIN SWITCHES WITH EMERGENCY FUNCTION

Dimensions in mm

DIN rail mounting with simplified door clutches

IP66/67/69k

Locking device, single-hole mounting 22 mm

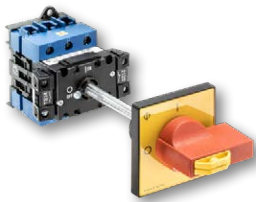

For 3 padlocks

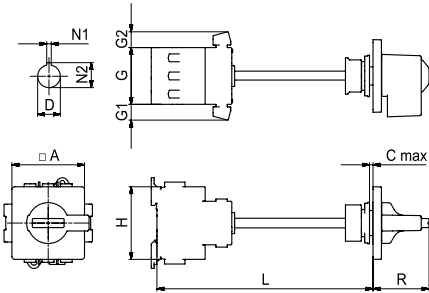
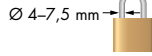

Name	Art. no.	Name	Art. no.
------	----------	------	----------

With cam-controlled auxiliary contact 1x NO

3-pole	KA40B.T203/72.VE	70031412	KA40B.T103/72.VE	70031394
	KA40BT.T203/72.VE	70032670	KA40BT.T103/72.VE	70032626
	KA63B.T203/72.VE	70031414	KA63B.T103/72.VE	70031395
	KA63BT.T203/72.VE	70032684	KA63BT.T103/72.VE	70032746

N1	N2	D	A	G	G1	G2	H	L	R	C max
3,2	24,1	22,3	64	50	14	-	64	170-195	49,4	4

With cam-controlled auxiliary contacts 1x NO/1x NC

3-pole	KA40B.T203/A5.VE	70032560	KA40B.T103/A5.VE	70032548
	KA40BT.T203/A5.VE	70032779	KA40BT.T103/A5.VE	70032762
	KA63B.T203/A5.VE	70032561	KA63B.T103/A5.VE	70032549
	KA63BT.T203/A5.VE	70032656	KA63BT.T103/A5.VE	70032674

N1	N2	D	A	G	G1	G2	H	L	R	C max
3,2	24,1	22,3	64	50	14	14	64	170-195	49,4	4

DIN rail mounting with simplified door clutches and centering device

IP66/67/69k

Locking device, single-hole mounting 22 mm

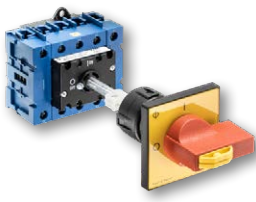

For 3 padlocks

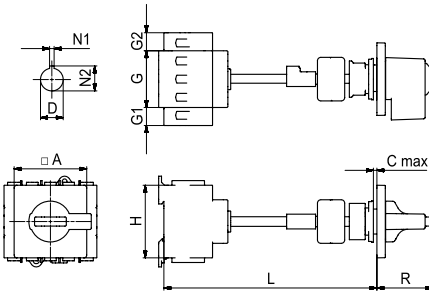
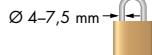

Name	Art. no.	Name	Art. no.
------	----------	------	----------

3-pole	KA40B.T203/94.VE	70031906	KA40B.T103/94.VE	70031901
	KA40BT.T203/94.VE	70033040	KA40BT.T103/94.VE	70032665
	KA63B.T203/94.VE	70031907	KA63B.T103/94.VE	70031902
	KA63BT.T203/94.VE	70032770	KA63BT.T103/94.VE	70032801

N1	N2	D	A	G	G1	G2	H	L	R	C max
3,2	24,1	22,3	64	50	-	-	64	175-190	49,4	4

PE+N ¹	3-pole	KA40B.T205/94.VE	70031937	KA40B.T105/94.VE	70031903
		KA40BT.T205/94.VE	70033041	KA40BT.T105/94.VE	70032812
		KA63B.T205/94.VE	70031430	KA63B.T105/94.VE	70031904
		KA63BT.T205/94.VE	70033011	KA63BT.T105/94.VE	70033000

N1	N2	D	A	G	G1	G2	H	L	R	C max
3,2	24,1	22,3	64	50	16	16	64	175-190	49,4	4

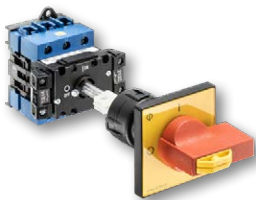

For 3 padlocks

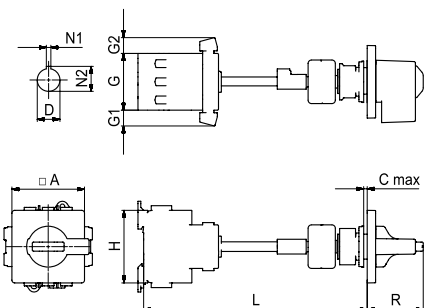
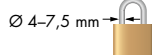

Name	Art. no.	Name	Art. no.
------	----------	------	----------

With cam-controlled auxiliary contact 1x NO

3-pole	KA40B.T203/96.VE	70031908	KA40B.T103/96.VE	70031431
	KA40BT.T203/96.VE	70032500	KA40BT.T103/96.VE	70032498
	KA63B.T203/96.VE	70031909	KA63B.T103/96.VE	70031432
	KA63BT.T203/96.VE	70032501	KA63BT.T103/96.VE	70032499

N1	N2	D	A	G	G1	G2	H	L	R	C max
3,2	24,1	22,3	64	50	14	-	64	175-200	49,4	4

With cam-controlled auxiliary contacts 1x NO/1x NC

3-pole	KA40B.T203/A7.VE	70032564	KA40B.T103/A7.VE	70032552
	KA40BT.T203/A7.VE	70032754	KA40BT.T103/A7.VE	70032788
	KA63B.T203/A7.VE	70032565	KA63B.T103/A7.VE	70032553
	KA63BT.T203/A7.VE	70032808	KA63BT.T103/A7.VE	70032747

N1	N2	D	A	G	G1	G2	H	L	R	C max
3,2	24,1	22,3	64	50	14	14	64	175-200	49,4	4

¹ Through-type connector

DIN rail mounting with simplified door clutches and centering device

IP66/67/69k

Locking device (F-handle), single-hole mounting 22 mm

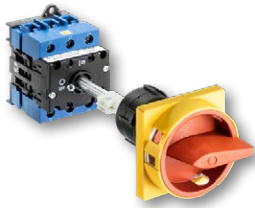

For 3 padlocks

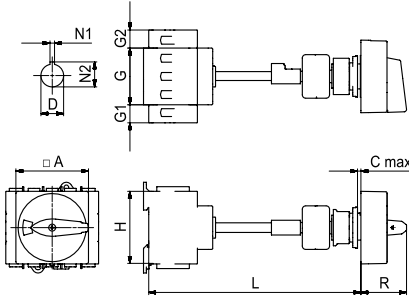
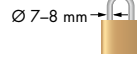

		Name	Art. no.		Name	Art. no.	
--	---	------	----------	---	------	----------	---

3-pole	KA40B.T203/93.VE	70022746	KA40B.T103/93.VE	70022745	+
	KA40BT.T203/93.VE	70032819	KA40BT.T103/93.VE	70032813	+
	KA63B.T203/93.VE	70031905	KA63B.T103/93.VE	70031257	+
	KA63BT.T203/93.VE	70032639	KA63BT.T103/93.VE	70032823	+

N1	N2	D	A	G	G1	G2	H	L	R	C _{max}
3,2	24,1	22,3	64	50	-	-	64	175-190	40	4



PE + N ¹ 3-pole	KA40B.T205/93.VE	70031421	KA40B.T105/93.VE	70031274	+
	KA40BT.T205/93.VE	70033039	KA40BT.T105/93.VE	70033034	+
	KA63B.T205/93.VE	70031936	KA63B.T105/93.VE	70031399	+
	KA63BT.T205/93.VE	70033002	KA63BT.T105/93.VE	70032805	+

N1	N2	D	A	G	G1	G2	H	L	R	C _{max}
3,2	24,1	22,3	64	50	16	16	64	175-190	40	4

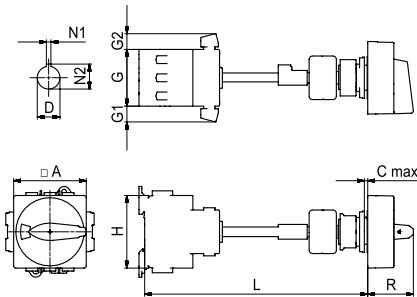
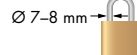

For 3 padlocks



		Name	Art. no.		Name	Art. no.	
--	---	------	----------	---	------	----------	---

With cam-controlled auxiliary contact 1x NO

3-pole	KA40B.T203/95.VE	70032814	KA40B.T103/95.VE	70032784	+
	KA40BT.T203/95.VE	70032683	KA40BT.T103/95.VE	70032672	+
	KA63B.T203/95.VE	70033001	KA63B.T103/95.VE	70032802	+
	KA63BT.T203/95.VE	70032753	KA63BT.T103/95.VE	70032761	+

N1	N2	D	A	G	G1	G2	H	L	R	C _{max}
3,2	24,1	22,3	64	50	14	-	64	175-200	40	4

With cam-controlled auxiliary contacts 1x NO/1x NC

3-pole	KA40B.T203/A6.VE	70032562	KA40B.T103/A6.VE	70032550	+
	KA40BT.T203/A6.VE	70032771	KA40BT.T103/A6.VE	70032803	+
	KA63B.T203/A6.VE	70032563	KA63B.T103/A6.VE	70032551	+
	KA63BT.T203/A6.VE	70032821	KA63BT.T103/A6.VE	70032650	+

N1	N2	D	A	G	G1	G2	H	L	R	C _{max}
3,2	24,1	22,3	64	50	14	14	64	175-200	40	4

¹ Through-type connector

MAIN SWITCHES WITH EMERGENCY FUNCTION

Dimensions in mm

DIN rail mounting with door clutches

IP66/67

Locking device (F-handle)

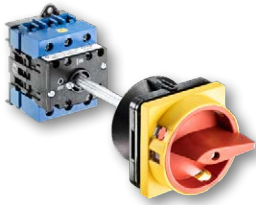

For 3 padlocks

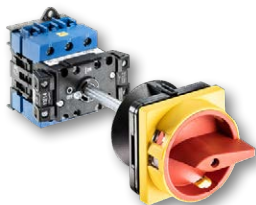
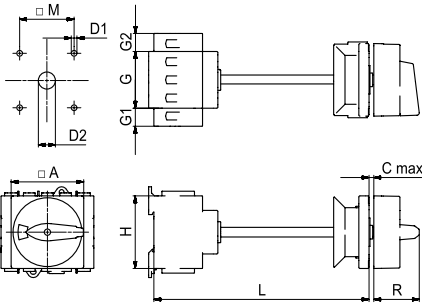
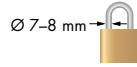

For 3 padlocks

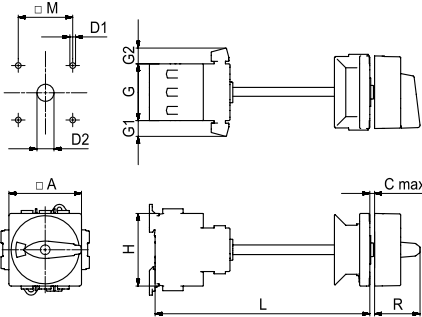
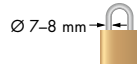

Name	Art. no.	Name	Art. no.
------	----------	------	----------

3-pole	KA40B.T203/09.VE	70022744	KA40B.T103/09.VE	70022743	+
	KA40BT.T203/09.VE	70032663	KA40BT.T103/09.VE	70032192	*
	KA63B.T203/09.VE	70024354	KA63B.T103/09.VE	70024349	+
	KA63BT.T203/09.VE	70032810	KA63BT.T103/09.VE	70032197	*

D1	D2	M	A	G	G1	G2	H	L	R	C _{max}
5	10-15	48	64	50	-	-	64	175-190	40	4

PE+N ¹ 3-pole	KA40B.T205/09.VE	70031419	KA40B.T105/09.VE	70031258	+
	KA40BT.T205/09.VE	70032999	KA40BT.T105/09.VE	70032800	*
	KA63B.T205/09.VE	70031916	KA63B.T105/09.VE	70031333	+
	KA63BT.T205/09.VE	70033020	KA63BT.T105/09.VE	70033032	*

D1	D2	M	A	G	G1	G2	H	L	R	C _{max}
5	10-15	48	64	50	16	16	64	175-190	40	4

Name	Art. no.	Name	Art. no.
------	----------	------	----------

With cam-controlled auxiliary contact 1x NO

3-pole	KA40B.T203/25.VE	70031286	KA40B.T103/25.VE	70031130	+
	KA40BT.T203/25.VE	70032806	KA40BT.T103/25.VE	70032491	*
	KA63B.T203/25.VE	70031287	KA63B.T103/25.VE	70031132	+
	KA63BT.T203/25.VE	70032822	KA63BT.T103/25.VE	70032493	*

D1	D2	M	A	G	G1	G2	H	L	R	C _{max}
5	10-15	48	64	50	14	-	64	175-200	40	4

With cam-controlled auxiliary contacts 1x NO/1x NC

3-pole	KA40B.T203/A8.VE	70032599	KA40B.T103/A8.VE	70032625	+
	KA40BT.T203/A8.VE	70032798	KA40BT.T103/A8.VE	70032815	*
	KA63B.T203/A8.VE	70032636	KA63B.T103/A8.VE	70032648	+
	KA63BT.T203/A8.VE	70032671	KA63BT.T103/A8.VE	70032632	*

D1	D2	M	A	G	G1	G2	H	L	R	C _{max}
5	10-15	48	64	50	14	14	64	175-200	40	4

Locking device

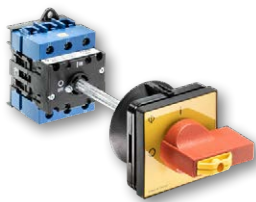

For 3 padlocks

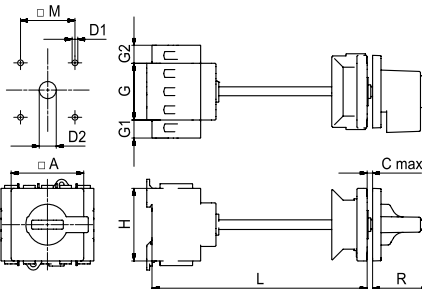
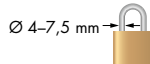

Name	Art. no.	Name	Art. no.
------	----------	------	----------

3-pole	KA40B.T203/65.VE	70031290	KA40B.T103/65.VE	70031217	+
	KA40BT.T203/65.VE	70032766	KA40BT.T103/65.VE	70032572	*
	KA63B.T203/65.VE	70031293	KA63B.T103/65.VE	70031218	+
	KA63BT.T203/65.VE	70032793	KA63BT.T103/65.VE	70032573	*

D1	D2	M	A	G	G1	G2	H	L	R	C _{max}
5	10-15	48	64	50	-	-	64	175-190	49,8	4

PE+N ¹ 3-pole	KA40B.T205/65.VE	70031926	KA40B.T105/65.VE	70031271	+
	KA40BT.T205/65.VE	70033044	KA40BT.T105/65.VE	70033021	*
	KA63B.T205/65.VE	70031927	KA63B.T105/65.VE	70031335	+
	KA63BT.T205/65.VE	70033033	KA63BT.T105/65.VE	70033043	*

D1	D2	M	A	G	G1	G2	H	L	R	C _{max}
5	10-15	48	64	50	16	16	64	175-190	49,8	4

¹ Through-type connector

DIN rail mounting with door clutches

IP66/67

Locking device

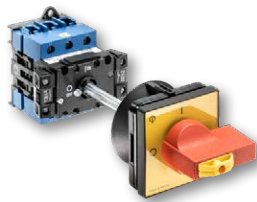

For 3 padlocks
 \varnothing 4-7,5 mm

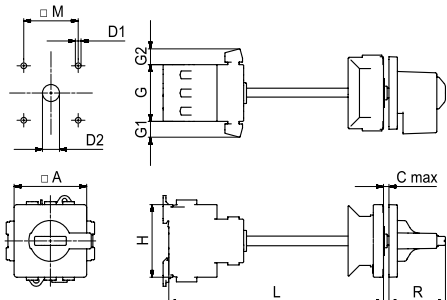

Name	Art. no.	Name	Art. no.
------	----------	------	----------

With cam-controlled auxiliary contact 1x NO

3-pole	KA40B.T203/69.VE	70031297	KA40B.T103/69.VE	70031239	+
	KA40BT.T203/69.VE	70033009	KA40BT.T103/69.VE	70032649	+
	KA63B.T203/69.VE	70031298	KA63B.T103/69.VE	70031249	+
	KA63BT.T203/69.VE	70032807	KA63BT.T103/69.VE	70032634	+

D1	D2	M	A	G	G1	G2	H	L	R	C _{max}
5	10-15	48	64	50	14	-	64	175-200	49,8	4

With cam-controlled auxiliary contacts 1x NO/1x NC

3-pole	KA40B.T203/A9.VE	70032600	KA40B.T103/A9.VE	70032668	+
	KA40BT.T203/A9.VE	70032659	KA40BT.T103/A9.VE	70032824	+
	KA63B.T203/A9.VE	70032627	KA63B.T103/A9.VE	70032630	+
	KA63BT.T203/A9.VE	70032795	KA63BT.T103/A9.VE	70032678	+

D1	D2	M	A	G	G1	G2	H	L	R	C _{max}
5	19-22	48	64	50	14	14	64	175-200	49,8	4

DIN rail mounting with simplified door clutches and centering device

IP66

Locking device

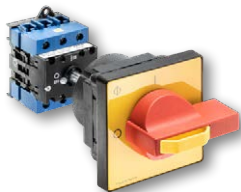

For 3 padlocks
 \varnothing 4-8 mm

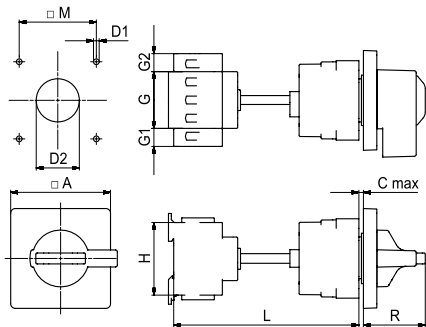

Name	Art. no.	Name	Art. no.
------	----------	------	----------

3-pole	KA40B.T203/12.VE	70024340	KA40B.T103/12.VE	70022748	+
	KA40BT.T203/12.VE	70032669	KA40BT.T103/12.VE	70032198	+
	KA63B.T203/12.VE	70024355	KA63B.T103/12.VE	70024350	+
	KA63BT.T203/12.VE	70033037	KA63BT.T103/12.VE	70032199	+

D1	D2	M	A	G	G1	G2	H	L	R	C _{max}
5	39-42	48	88	50	-	-	64	155-170	54,5	5,5

PE+N ¹ 3-pole	KA40B.T205/12.VE	70031924	KA40B.T105/12.VE	70031265	+
	KA40BT.T205/12.VE	70033046	KA40BT.T105/12.VE	70032631	+
	KA63B.T205/12.VE	70031925	KA63B.T105/12.VE	70031334	+
	KA63BT.T205/12.VE	70033010	KA63BT.T105/12.VE	70033004	+

D1	D2	M	A	G	G1	G2	H	L	R	C _{max}
5	39-42	48	88	50	16	16	64	155-170	54,5	5,5

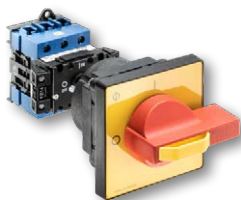

For 3 padlocks
 \varnothing 4-8 mm

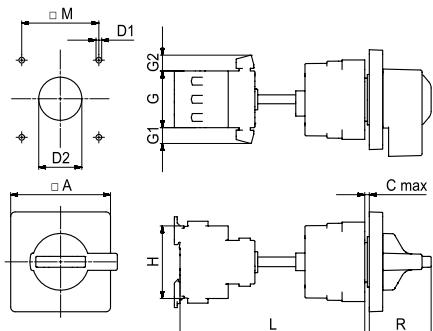

Name	Art. no.	Name	Art. no.
------	----------	------	----------

With cam-controlled auxiliary contact 1x NO

3-pole	KA40B.T203/28.VE	70031288	KA40B.T103/28.VE	70031140	+
	KA40BT.T203/28.VE	70033019	KA40BT.T103/28.VE	70032495	+
	KA63B.T203/28.VE	70031289	KA63B.T103/28.VE	70031141	+
	KA63BT.T203/28.VE	70032655	KA63BT.T103/28.VE	70032566	+

D1	D2	M	A	G	G1	G2	H	L	R	C _{max}
5	39-42	48	88	50	14	-	64	155-180	54,5	5,5

With cam-controlled auxiliary contacts 1x NO/1x NC

3-pole	KA40B.T203/B1.VE	70032601	KA40B.T103/B1.VE	70032783	+
	KA40BT.T203/B1.VE	70032794	KA40BT.T103/B1.VE	70032998	+
	KA63B.T203/B1.VE	70032647	KA63B.T103/B1.VE	70032637	+
	KA63BT.T203/B1.VE	70032751	KA63BT.T103/B1.VE	70032765	+

D1	D2	M	A	G	G1	G2	H	L	R	C _{max}
5	39-42	48	88	50	14	14	64	155-180	54,5	5,5

¹ Through-type connector

MAINTENANCE SWITCHES

Dimensions in mm

In plastic enclosure

IP66/67/69k

Locking device (B-handle)



For 3 padlocks

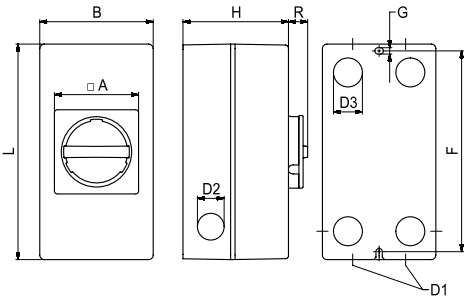
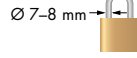

For 3 padlocks

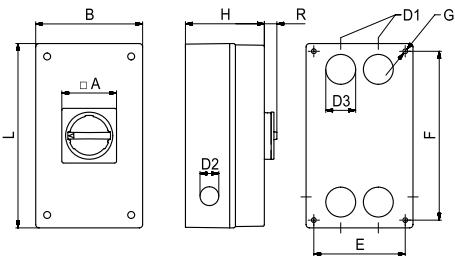
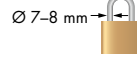

For 3 padlocks

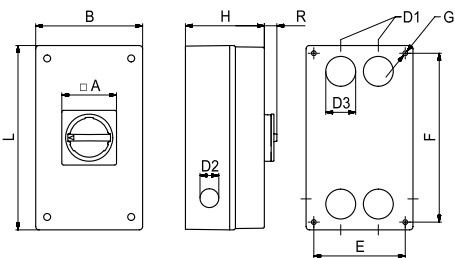
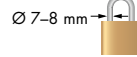

				
	Name	Art. no.	Name	Art. no.

3-pole	KA40.T203/33.KL11V	70024341	KA40.T103/33.KL11V	70024323	+
	KA40T.T203/33.KL11V	70031922	KA40T.T103/33.KL11V	70032184	+
	KA63.T203/33.KL11V	70030991	KA63.T103/33.KL11V	70031142	+
	KA63TT203/33.KL11V	70032569	KA63TT103/33.KL11V	70032567	+

A	B	D1	D2	D3	F	G	H	L	R
74	100	M25	M25	M25	177	5,6	93	190	17

With cam-controlled auxiliary contacts 1x NO/1x NC

3-pole	KA40.T203/40.KL11V	70012698	KA40.T103/40.KL11V	70012697	+
	KA40T.T203/40.KL11V	70032792	KA40T.T103/40.KL11V	70032570	+
	KA63.T203/40.KL11V	70024498	KA63.T103/40.KL11V	70024497	+
	KA63TT203/40.KL11V	70032673	KA63TT103/40.KL11V	70032571	+

A	B	D1	D2	D3	F	G	H	L	R
74	100	M25	M25	M25	177	5,6	93	190	17

				
	Name	Art. no.	Name	Art. no.

3-pole	KA40.T203/33.KL71V	70048993	KA40.T103/33.KL71V	70048996	+
	KA40T.T203/33.KL71V	70048994	KA40T.T103/33.KL71V	70048997	+
	KA63.T203/33.KL71V	70031923	KA63.T103/33.KL71V	70032176	+
	KA63TT203/33.KL71V	70032182	KA63TT103/33.KL71V	70031919	+

A	B	D1	D2	D3	E	F	G	H	L	R
74	145	M25/40	M25	M40	124	229	6,5	107	250	17

With cam-controlled auxiliary contacts 1x NO/1x NC

3-pole	KA40.T203/40.KL71V	70048998	KA40.T103/40.KL71V	70049004	+
	KA40T.T203/40.KL71V	70049001	KA40T.T103/40.KL71V	70049005	+
	KA63.T203/40.KL71V	70014370	KA63.T103/40.KL71V	70014368	+
	KA63TT203/40.KL71V	70032183	KA63TT103/40.KL71V	70031932	+

A	B	D1	D2	D3	E	F	G	H	L	R
74	145	M25/40	M25	M40	124	229	6,5	107	250	17

				
	Name	Art. no.	Name	Art. no.

6-pole	KA40B.T206/33.KL71V	70035143	KA40B.T106/33.KL71V	70035129	+
	KA40BT.T206/33.KL71V	70035138	KA40BT.T106/33.KL71V	70035161	+
	KA63B.T206/33.KL71V	70035142	KA63B.T106/33.KL71V	70035157	+
	KA63BT.T206/33.KL71V	70035130	KA63BT.T106/33.KL71V	70035153	+

A	B	D1	D2	D3	E	F	G	H	L	R
74	145	M25/40	M25	M40	124	229	6,5	107	250	17

With cam-controlled auxiliary contacts 1x NO/1x NC

6-pole	KA40B.T206/40.KL71V	70035155	KA40B.T106/40.KL71V	70035139	+
	KA40BT.T206/40.KL71V	70035148	KA40BT.T106/40.KL71V	70035136	+
	KA63B.T206/40.KL71V	70035126	KA63B.T106/40.KL71V	70035150	+
	KA63BT.T206/40.KL71V	70035124	KA63BT.T106/40.KL71V	70035160	+

A	B	D1	D2	D3	E	F	G	H	L	R
74	145	M25/40	M25	M40	124	229	6,5	107	250	17

In plastic enclosure

IP66/67/69k

Locking device



For 3 padlocks

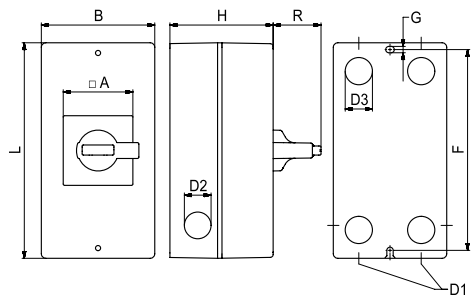
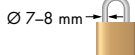

For 3 padlocks

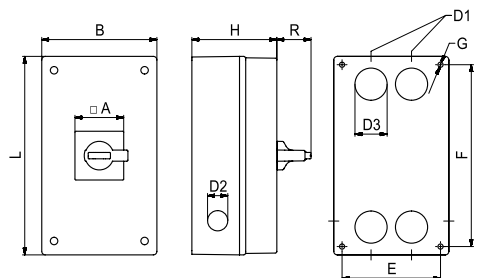
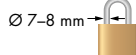

	Name	Art. no.		Name	Art. no.
---	------	----------	---	------	----------

3-pole	KA40.T203/75.KL11	70031301	KA40.T103/75.KL11	70031253	+
	KA40T.T203/75.KL11	70032643	KA40T.T103/75.KL11	70032646	+
	KA63.T203/75.KL11	70031302	KA63.T103/75.KL11	70031254	+
	KA63T.T203/75.KL11	70032809	KA63T.T103/75.KL11	70032677	+

A	B	D1	D2	D3	E	F	G	H	L	R
64	145	M25/40	M25	M40	124	229	6,5	107	250	43

With cam-controlled auxiliary contacts 1x NO/1x NC

3-pole	KA40.T203/78.KL11	70031303	KA40.T103/78.KL11	70031255	+
	KA40T.T203/78.KL11	70032662	KA40T.T103/78.KL11	70032757	+
	KA63.T203/78.KL11	70031417	KA63.T103/78.KL11	70031256	+
	KA63T.T203/78.KL11	70032796	KA63T.T103/78.KL11	70032785	+

A	B	D1	D2	D3	E	F	G	H	L	R
62	100	M25	M25	M40	124	177	5,6	91	190	43

	Name	Art. no.		Name	Art. no.
---	------	----------	---	------	----------

6-pole	KA40B.T206/75.KL71	70035146	KA40B.T106/75.KL71	70035123	+
	KA40BT.T206/75.KL71	70035141	KA40BT.T106/75.KL71	70035134	+
	KA63B.T206/75.KL71	70035137	KA63B.T106/75.KL71	70035147	+
	KA63BT.T206/75.KL71	70035156	KA63BT.T106/75.KL71	70035149	+

A	B	D1	D2	D3	E	F	G	H	L	R
64	145	M25/40	M25	M40	124	229	6,5	107	250	43

With cam-controlled auxiliary contact 1x NO

6-pole	KA40B.T206/78.KL71	70035152	KA40B.T106/78.KL71	70035132	+
	KA40BT.T206/78.KL71	70035133	KA40BT.T106/78.KL71	70035128	+
	KA63B.T206/78.KL71	70035131	KA63B.T106/78.KL71	70035151	+
	KA63BT.T206/78.KL71	70035158	KA63BT.T106/78.KL71	70035144	+

A	B	D1	D2	D3	E	F	G	H	L	R
62	145	M25/40	M25	M40	124	229	6,5	107	250	43

In plastic enclosure (EMC)

IP66/67

Locking device (B-handle)



For 3 padlocks
 Ø 7-8 mm

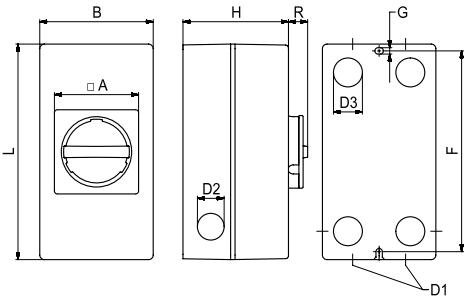

For 3 padlocks
 Ø 7-8 mm

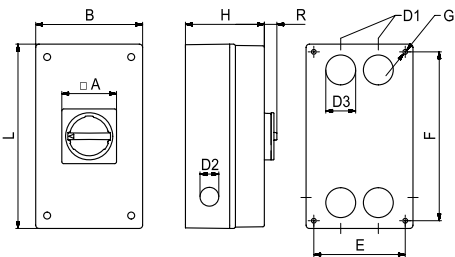

For 3 padlocks
 Ø 7-8 mm

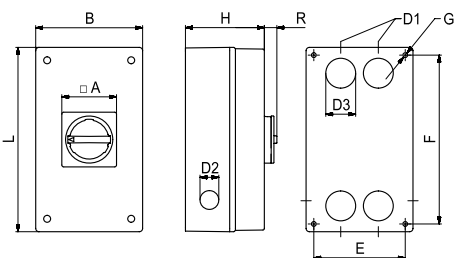

	Name	Art. no.		Name	Art. no.	
--	------	----------	--	------	----------	--

With cam-controlled auxiliary contacts 1x NO/1x NC

3-pole	KA40.T203/E1.KL11V	70031247	KA40.T103/E1.KL11V	70031241	
	KA40T.T203/E1.KL11V	70031328	KA40T.T103/E1.KL11V	70031320	

A	B	D1	D2	D3	F	G	H	L	R
74	100	M25	M25	M25	177	5,6	93	190	17

	Name	Art. no.		Name	Art. no.	
--	------	----------	--	------	----------	--

With cam-controlled auxiliary contacts 1x NO/1x NC

3-pole	KA40.T203/E1.KL71V	70049007	KA40.T103/E1.KL71V	70049011	
	KA40T.T203/E1.KL71V	70049009	KA40T.T103/E1.KL71V	70049014	
	KA63.T203/E1.KL71V	70031244	KA63.T103/E1.KL71V	70031252	
	KA63T.T203/E1.KL71V	70031326	KA63T.T103/E1.KL71V	70031324	

A	B	D1	D2	D3	E	F	G	H	L	R
74	145	M25/40	M25	M40	124	229	6,5	107	250	17

4-pole	KA40.T204/E1.KL71V	70031246	KA40.T104/E1.KL71V	70031250	
	KA40T.T204/E1.KL71V	70031329	KA40T.T104/E1.KL71V	70031325	
	KA63.T204/E1.KL71V	70031243	KA63.T104/E1.KL71V	70031248	
	KA63T.T204/E1.KL71V	70031322	KA63T.T104/E1.KL71V	70031327	

A	B	D1	D2	D3	E	F	G	H	L	R
74	145	M25/40	M25	M40	124	229	6,5	107	250	17

	Name	Art. no.		Name	Art. no.	
--	------	----------	--	------	----------	--

With cam-controlled auxiliary contacts 1x NO/1x NC

6-pole	KA40B.T206/E1.KL71V	70038156	KA40B.T106/E1.KL71V	70037283	
	KA40BT.T206/E1.KL71V	70039500	KA40BT.T106/E1.KL71V	70039498	
	KA63B.T206/E1.KL71V	70039502	KA63B.T106/E1.KL71V	70037281	
	KA63BT.T206/E1.KL71V	70039509	KA63BT.T106/E1.KL71V	70039508	

A	B	D1	D2	D3	E	F	G	H	L	R
74	145	M25/40	M25	M40	124	229	6,5	107	250	17

Notice:



Maintenance switches designed for EMC-compliant connecting of cycloconverter drives are equipped with shield brackets (KS and KL enclosures) or clamp-type terminals mounted on rail (STM enclosure) in order to enable the uninterrupted transmission of the cable shield.

In plastic enclosure in accordance with EN 2626-1 class 0

IP66/67/69k

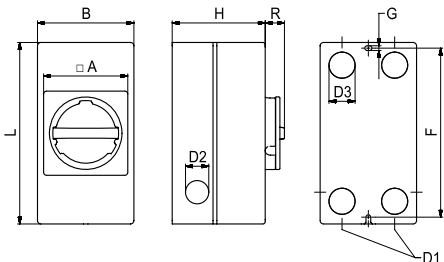
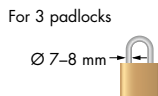
Locking device (B-handle)



	Name	Art. no.		Name	Art. no.
---	------	----------	---	------	----------

With cam-controlled auxiliary contacts 1x NO/1x NC

3-pole	KA40.T203/WASIO2.KL12V	70032591	KA40.T103/WASIO2.KL12V	70035459	+
	KA40T.T203/WASIO2.KL12V	70048810	KA40T.T103/WASIO2.KL12V	70048809	+
	KA63.T203/WASIO2.KL12V	70035461	KA63.T103/WASIO2.KL12V	70035460	+
	KA63T.T203/WASIO2.KL12V	70048812	KA63T.T103/WASIO2.KL12V	70048811	+

A	B	D1	D2	D3	F	G	H	L	R
74	100	M25	M25	M25	177	5,6	93	190	17

Notice:

The safety switches according to DIN EN 62626-1 class 0 are equipped with a cover interlock which allows the cover to be removed in position "I" only. The basic requirements of these devices are derived from switch disconnectors in accordance with IEC 60947-3. Furthermore, our safety switches according to DIN EN 62626-1 class 0 have the following characteristics:

- IK06 impact resistance in accordance with IEC 62262
- IP66/67 International Protection in accordance with IEC60529
- AC-23A switching capacity in accordance with IEC60947-3
- Cover interlock in order to prevent the opening of the enclosure in "OFF" position
- Suitable for installation of up to 3 padlocks
- Temperature-rise test, salt spray test, vibration test, category A in accordance with IEC60947-1 Annex Q

In plastic enclosure (EMC) in accordance with EN 2626-1 class 0

IP66/67

Locking device (F-handle)

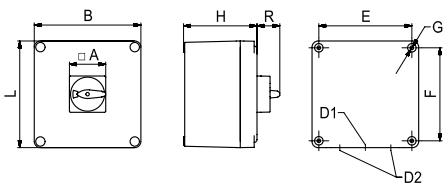
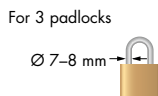

	Name	Art. no.		Name	Art. no.
---	------	----------	---	------	----------

With cam-controlled auxiliary contacts 1x NO/1x NC

3-pole	KA40B.T203/WASIO1.STM	70032595	KA40B.T103/WASIO1.STM	70035567	+
	KA40BT.T203/WASIO1.STM	70048800	KA40BT.T103/WASIO1.STM	70048799	+
	KA63B.T203/WASIO1.STM	70035569	KA63B.T103/WASIO1.STM	70035568	+
	KA63BT.T203/WASIO1.STM	70048806	KA63BT.T103/WASIO1.STM	70048804	+

A	B	D1	D2	E	F	G	H	L	R
64	190	M16	M40	164	164	6,5	130	190	40,2

With cam-controlled auxiliary contacts 1x NO/1x NC

6-pole	KA40B.T206/WASIO1.STM	70039562	KA40B.T106/WASIO1.STM	70039560	+
	KA40BT.T206/WASIO1.STM	70048802	KA40BT.T106/WASIO1.STM	70048801	+
	KA63B.T206/WASIO1.STM	70039566	KA63B.T106/WASIO1.STM	70039564	+
	KA63BT.T206/WASIO1.STM	70048808	KA63BT.T106/WASIO1.STM	70048807	+

A	B	D1	D2	E	F	G	H	L	R
64	190	M16	M40	164	164	6,5	130	280	40,2

Notice:

The safety switches according to DIN EN 62626-1 class 0 are equipped with a cover interlock which allows the cover to be removed in position "I" only. The basic requirements of these devices are derived from switch disconnectors in accordance with IEC 60947-3. Furthermore, our safety switches according to DIN EN 62626-1 class 0 have the following characteristics:

- IK06 impact resistance in accordance with IEC 62262
- IP66/67 International Protection in accordance with IEC60529
- AC-23A switching capacity in accordance with IEC60947-3
- Cover interlock in order to prevent the opening of the enclosure in "OFF" position
- Suitable for installation of up to 3 padlocks
- Temperature-rise test, salt spray test, vibration test, category A in accordance with IEC60947-1 Annex Q

Maintenance switches designed for EMC compliant connecting of variable speed drives are equipped with shield brackets (KS- and KL-enclosures) or clamps mounted on rail (STM enclosure). Enabling a large scale uninterrupted transmission of the shield.

SWITCH DISCONNECTORS

Dimensions in mm

Front mounting, 4-hole mounting

IP66/67

Standard handle

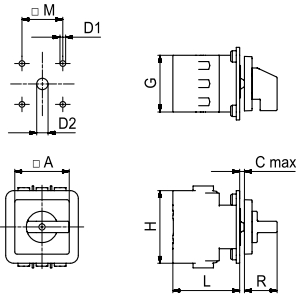

Name	Art. no.

3-pole	Name	Art. no.	
	KA40.T303.E	70031122	+
	KA40T.T303.E	70031124	+
	KA63.T303.E	70031123	+
	KA63T.T303.E	70031125	+

D1	D2	M	A	G	H	L	R	C max
5	10-15	36	48	50	64	58,9	28,8	4

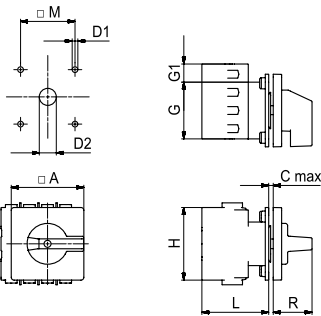

Name	Art. no.

4-pole	Name	Art. no.	
	KA40B.T303.E	70031113	+
	KA40BT.T303.E	70031950	+
	KA63B.T303.E	70031114	+
	KA63BT.T303.E	70031952	+

D1	D2	M	A	G	G1	H	L	R	C max
5	10-15	36	64	50	-	64	58,9	34,2	4

4-pole	Name	Art. no.	
	KA40B.T304.E	70031106	+
	KA40BT.T304.E	70031953	+
	KA63B.T304.E	70049016	+
	KA63BT.T304.E	70049017	+

D1	D2	M	A	G	G1	H	L	R	C max
5	10-15	36	64	50	16	64	58,9	34,2	4

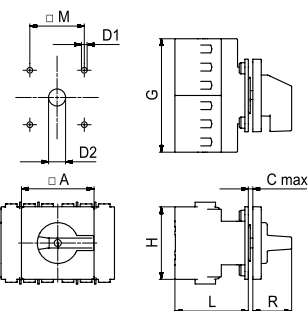

Name	Art. no.

6-pole	Name	Art. no.	
	KA40B.T306.E	70034209	+
	KA40BT.T306.E	70035170	+
	KA63B.T306.E	70035166	+
	KA63BT.T306.E	70035185	+

D1	D2	M	A	G	H	L	R	C max
5	10-15	48	64	100	64	64,7	34,2	4

Front mounting, single-hole mounting 22mm

IP66/67/69k

Standard handle



Name	Art. no.	
------	----------	--

3-pole	KA40.T303.FT2	70033557	+
	KA40T.T303.FT2	70035462	+
	KA63.T303.FT2	70035464	+
	KA63T.T303.FT2	70035465	+

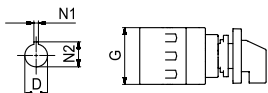

N1	N2	D	A	G	H	L	R	C _{max}
3,2	24,1	22,3	48	50	64	82,2	29,2	4

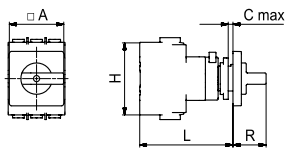

Name	Art. no.	
------	----------	--

6-pole	KA40B.T306.FH3	70034276	+
	KA40BT.T306.FH3	70035546	+
	KA63B.T306.FH3	70035547	+
	KA63BT.T306.FH3	70035548	+

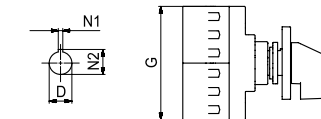

N1	N2	D	A	G	H	L	R	C _{max}
3,2	24,1	22,3	64	100	64	87,6	35,2	4

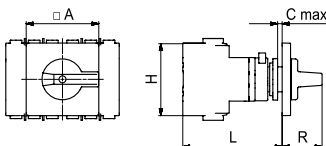

DIN rail mounting

IP40

Standard handle



Name	Art. no.	
------	----------	--

3-pole	KA40.T303.VE	70031105	+
	KA40T.T303.VE	70031115	+
	KA63.T303.VE	70031108	+
	KA63T.T303.VE	70031116	+

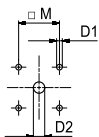

D1	D2	M	A	G	H	L	R	C _{max}
5	10-15	36	48	50	64	65	28,8	12

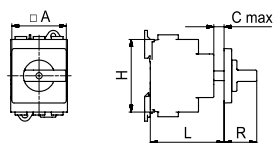

SWITCH DISCONNECTORS

Dimensions in mm

DIN rail mounting

IP40

Standard handle

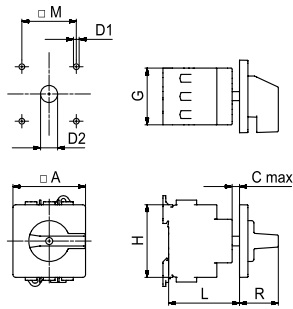

Name	Art. no.

3-pole	Name	Art. no.	+
	KA40B.T303.VE	70031107	+
	KA40BT.T303.VE	70031949	+
	KA63B.T303.VE	70031109	+
	KA63BT.T303.VE	70031948	+

D1	D2	M	A	G	H	L	R	C max
5	10-15	48	64	50	64	62,5	34,2	12

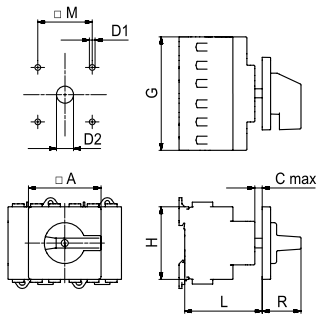

Name	Art. no.

6-pole	Name	Art. no.	+
	KA40B.T306.VE	70034216	+
	KA40BT.T306.VE	70035177	+
	KA63B.T306.VE	70035178	+
	KA63BT.T306.VE	70035186	+

D1	D2	M	A	G	H	L	R	C max
5	10-15	48	64	100	64	68,3	34,2	12

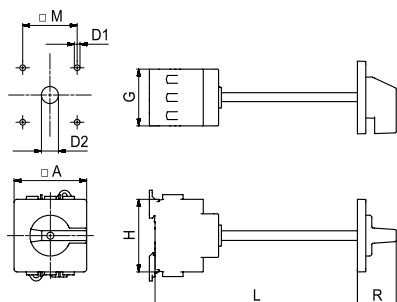
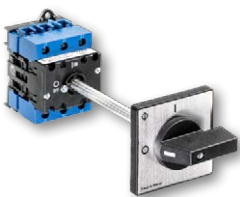

Name	Art. no.

3-pole	Name	Art. no.	+
	KA40B.T303/57.VE	70031401	+
	KA40BT.T303/57.VE	70032658	+
	KA63B.T303/57.VE	70031402	+
	KA63BT.T303/57.VE	70032774	+

D1	D2	M	A	G	H	L	R
5	10-15	48	64	50	64	180-195	34,2

DIN rail mounting

IP40

Standard handle

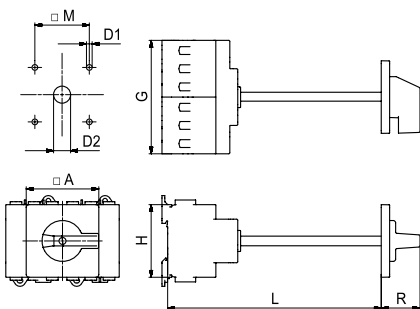
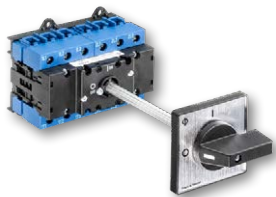

Name	Art. no.	
		

6-pole	KA40B.T306/57.VE	70035159	+
	KA40BT.T306/57.VE	70035145	+
	KA63B.T306/57.VE	70035140	+
	KA63BT.T306/57.VE	70035125	+



D1	D2	M	A	G	H	L	R
5	10-15	48	64	100	64	180-195	34,2

DIN rail mounting, for 45 mm standard cutout

IP40

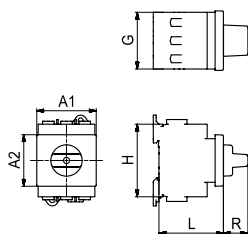
B-handle



Name	Art. no.	
		

3-pole	KA40.T303.VE2	70031110	+
	KA40T.T303.VE2	70031117	+
	KA63.T303.VE2	70024369	+
	KA63T.T303.VE2	70031118	+

A1	A2	G	H	L	R
52,4	45,4	50	64	56,8	21,6



Locking device

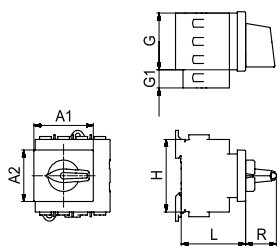

For 1 padlock

Ø 4,5-6 mm 



Name	Art. no.	
		

3-pole	KA40.T303/58.VE2	70024359	+
	KA40T.T303/58.VE2	70032752	+
	KA63.T303/58.VE2	70024371	+
	KA63T.T303/58.VE2	70032638	+

A1	A2	G	G1	H	L	R
52,4	45,4	50	-	64	56,8	27

4-pole	KA40.T304/58.VE2	70024366	+
	KA40T.T304/58.VE2	70031929	+
	KA63.T304/58.VE2	70024358	+
	KA63T.T304/58.VE2	70031918	+

A1	A2	G	G1	H	L	R
52,4	45,4	50	16	64	56,8	27

SWITCH DISCONNECTORS



Dimensions in mm

Plastic enclosure

IP66/67/69k

Standard handle



	Name	Art. no.	
---	-------------	-----------------	---

3-pole	KA40.T303.KL11	70031111	+
	KA40T.T303.KL11	70031119	+
	KA63.T303.KL11	70031112	+
	KA63T.T303.KL11	70031120	+

A	B	D1	D2	D3	F	G	H	L	R
64	100	M20/25	M25	M25	177	5,6	91	190	27

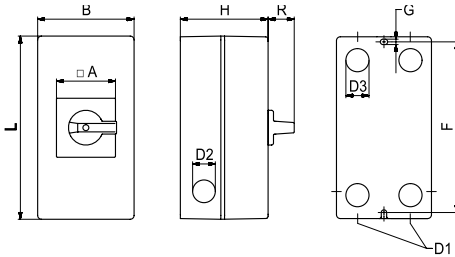

	Name	Art. no.	
--	-------------	-----------------	--

6-pole	KA40B.T306.KL71	70034220	+
	KA40BT.T306.KL71	70035165	+
	KA63B.T306.KL71	70035173	+
	KA63BT.T306.KL71	70035175	+

A	B	D1	D2	D3	E	F	G	H	L	R
64	145	M25/40	M25	M40	124	229	6,5	107	250	27

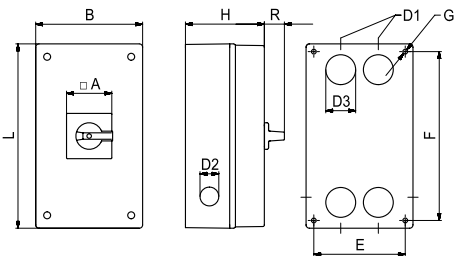

Front mounting, 4-hole mounting (Manual Transfer Switch)

IP66/67

Standard handle

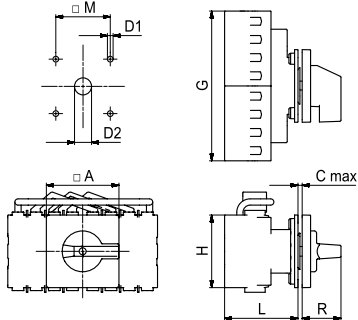

	Name	Art. no.		Art. no.	
--	------	----------	--	----------	--

3-pole	KA40B.T903.E	70034217	KA40B.T903.E.F445	70048438	+
	KA40BT.T903.E	70035180	KA40BT.T903.E.F445	70048439	+
	KA63B.T903.E	70035184	KA63B.T903.E.F445	70048440	+
	KA63BT.T903.E	70035187	KA63BT.T903.E.F445	70048441	+

D1	D2	M	A	G	H	L	R	Cmax
5	10-15	48	64	100	64	64,7	34,2	4

4-pole	KA40B.T904.E	70036427	KA40B.T904.E.F445	70048442	+
	KA40BT.T904.E	70048391	KA40BT.T904.E.F445	70048443	+
	KA63B.T904.E	70048392	KA63B.T904.E.F445	70048444	+
	KA63BT.T904.E	70048393	KA63BT.T904.E.F445	70048445	+

D1	D2	M	A	G	H	L	R	Cmax
5	10-15	48	64	132	64	64,7	34,2	4

DIN rail mounting

IP40

Standard handle

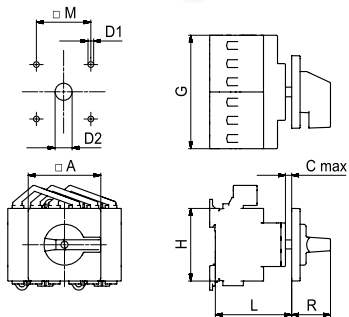

	Name	Art. no.	
--	------	----------	--

3-pole	KA40B.T903.VE	70034210	+
	KA40BT.T903.VE	70035169	+
	KA63B.T903.VE	70035179	+
	KA63BT.T903.VE	70035181	+

D1	D2	M	A	G	H	L	R	Cmax
5	10-15	48	64	100	64	67,3	34,2	12

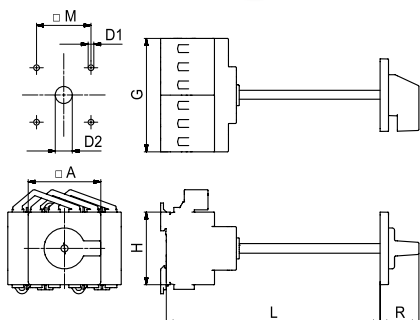
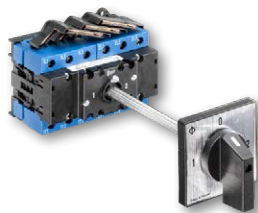

	Name	Art. no.	
--	------	----------	--

3-pole	KA40B.T903/57.VE	70035154	+
	KA40BT.T903/57.VE	70035162	+
	KA63B.T903/57.VE	70035122	+
	KA63BT.T903/57.VE	70035135	+

D1	D2	M	A	G	H	L	R
5	10-15	48	64	100	64	180-195	34,2

CHANGEOVER SWITCHES

Dimensions in mm

DIN rail mounting, for 45 mm standard cutout (Manual Transfer Switch)

IP40

F-handle

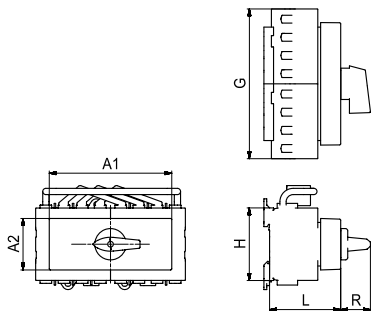

	Name	Art. no.		Name	Art. no.	
--	-------------	-----------------	--	-------------	-----------------	--

3-pole	KA40B.T903.VE2	70038129	KA40B.T903.VE2.F445	70048446	+
	KA40BT.T903.VE2	70035172	KA40BT.T903.VE2.F445	70048447	+
	KA63B.T903.VE2	70035167	KA63B.T903.VE2.F445	70048448	+
	KA63BT.T903.VE2	70035164	KA63BT.T903.VE2.F445	70048449	+

A1	A2	G	H	L	R
108	45,4	100	64	62,6	26

4-pole	KA40B.T904.VE2	70036433	KA40B.T904.VE2.F445	70048450	+
	KA40BT.T904.VE2	70048394	KA40BT.T904.VE2.F445	70048451	+
	KA63B.T904.VE2	70048395	KA63B.T904.VE2.F445	70048452	+
	KA63BT.T904.VE2	70048396	KA63BT.T904.VE2.F445	70048453	+

A1	A2	G	H	L	R
108	45,4	132	64	62,6	26

In plastic enclosure (Manual Transfer Switch)

IP66/67/69k

Standard handle

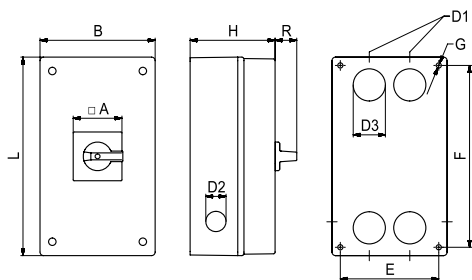

	Name	Art. no.		Name	Art. no.	
--	-------------	-----------------	--	-------------	-----------------	--

3-pole	KA40B.T903.KL70	70048397	KA40B.T903.KL70.F445	70048454	+
	KA40BT.T903.KL70	70048398	KA40BT.T903.KL70.F445	70048455	+
	KA63B.T903.KL70	70048399	KA63B.T903.KL70.F445	70048457	+
	KA63BT.T903.KL70	70048400	KA63BT.T903.KL70.F445	70048459	+

A	B	D1	D2	D3	E	F	G	H	L	R
64	145	M25/40	M25	M40	124	229	6,5	107	250	27

4-pole	KA40B.T904.KL70	70048401	KA40B.T904.KL70.F445	70048460	+
	KA40BT.T904.KL70	70048402	KA40BT.T904.KL70.F445	70048461	+
	KA63B.T904.KL70	70024774	KA63B.T904.KL70.F445	70048462	+
	KA63BT.T904.KL70	70048403	KA63BT.T904.KL70.F445	70048463	+

A	B	D1	D2	D3	E	F	G	H	L	R
64	145	M25/40	M25	M40	124	229	6,5	107	250	27

ADD-ON MODULES

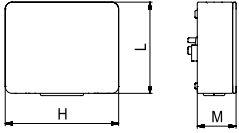

Front mounting Name	Art. no.	DIN rail mounting Name	Art. no.	
---------------------	----------	------------------------	----------	--

Lateral auxiliary contact 1NO + 1NC

K1.H010C/A11-A	2240561	K1.H010C/A11-B	2240563	+
--------------------------------	---------	--------------------------------	---------	---

H	L	M
50	40,2	17,1

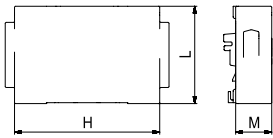

Front mounting Name	Art. no.	DIN rail mounting Name	Art. no.	
---------------------	----------	------------------------	----------	--

Ground terminal (PE)

K1.H052C/A1-A	2307944	K1.H052C/A1-B	2307945	+
K1.H052C/A2-A	2308043	K1.H052C/A2-B	2308042	+

Neutral terminal (N)

K1.H053C/A1-A	2307946	K1.H053C/A1-B	2307989	+
K1.H053C/A2-A	2308044	K1.H053C/A2-B	2308045	+

H	L	M
64	42,9	16

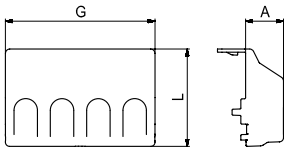

Front mounting Name	Art. no.	DIN rail mounting Name	Art. no.	
---------------------	----------	------------------------	----------	--

Terminal cover

3-pole	K1.M160/36	2313340	K1.M160/36	2313340	
4-pole	K1.M160/46	2313239	K1.M160/46	2313239	

A	G 3p	G 4p	L
16,7	50	66	42,9

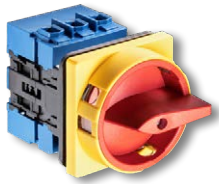

Switch types / Auxiliary contacts*				KA40	KA63	M510C*	H010C*	
				KA40B KA40T KA40BT	KA63B KA63T KA63BT	cam-controlled	laterally attachable	
IEC 60947-3, EN 60947-3, VDE 0660 part 107								
Rated insulation voltage U_i				V	690	690	690	690
Rated impulse withstand voltage U_{imp}				kV	6	6	-	-
Rated uninterrupted current $I_U/I_{th}/I_{the}$				A	40	63	16	16
Rated operational current I_e								
AC-15	3-phase, 3-pole	110 V–240 V 380 V–440 V 500 V	A	- - -	- - -	6 3 1,5	6 4 -	
AC-21A	3-phase, 3-pole	20 V–690 V	A	40	63	16	16	
AC-22A	3-phase, 3-pole	20 V–690 V	A	40	63	-	-	
Rated switching capacity								
AC-3	3-phase, 3-pole	220 V–240 V	kW	7,5	11	-	-	
		380 V–440 V		15	18,5	-	-	
		500 V		15	22	-	-	
		660 V–690 V		15	15	-	-	
AC-23A	3-phase, 3-pole	220 V–240 V	kW	11	11	-	-	
		380 V–440 V		20	22	-	-	
		500 V		25	30	-	-	
		660 V–690 V		25	25	-	-	
Short-circuit resistance								
Max. fuse rating		gG characteristic	A	50	63	-	-	
Rated short-time withstand current		(1 sec. current)	A	850	950	-	-	
Max. conductor cross section - Use only copper conductors								
solid / stranded wire			mm ²	25	25	2,5	2,5	
flexible wire			mm ²	16	16	2,5	2,5	
flexible wire with wire-end ferrules according to DIN 46228			mm ²	16	16	2,5	2,5	
USA / Canada								
Rated insulation voltage U_i				V	600	600	600	600
Rated operational current I_e								
Pilot Duty		Heavy	VAC	A600	A600	A600	A600	
Ampere Rating		600 V	A	42	60	10	10	
ON/OFF								
Max. conductor cross section - Use only copper conductors								
solid / stranded wire			AWG	4	4	12	12	
flexible wire: AWG wire (without wire-end ferrules)			AWG	6	6	14	14	
Switching capacity								
Motor normal load DOL-Rating (similar to AC-3)	3-phase, 3-pole	110 V–120 V	HP	5	5	-	-	
		220 V–240 V		15	15	-	-	
		440 V–480 V		25	30	-	-	
		550 V–600 V		30	40	-	-	
General technical information								
Twist torque Clamping screw				Nm/lb-in	2/18	2/18	0,6/5	0,6/5
Minimum voltage				upon request				
Power loss per pole at I_U					0,9 W	1,9 W	0,6 W	0,8 W
Recommended screwdriver								
Cross-tip screwdriver		PH2	KA40, KA40B, KA63, KA63B			PH1	PH1	
Torx screwdriver		T20	KA40T, KA40BT, KA63T, KA63BT			-	-	
Slot screwdriver		1,2x1,5	all			0,8x4	0,8x4	
Stripped length of the connection cable					15 mm	15 mm	8 mm	8 mm
Vibration resistance				min. 4 g, 2-100 Hz, 1,6 mm			-	-
Shock resistance				min. 5 g, 6 ms			-	-
Min. ambient temperature of contact unit				-5 °C				
Max. ambient temperature of contact unit				open at 100 % I_U/I_{th}	50 °C over 24 hours with peaks of up to 55 °C			
				encapsulated at 100 % I_{the}	35 °C over 24 hours with peaks of up to 40 °C			
Storage temperature				-40 °C up to 85 °C (at temperatures below -5 °C, no shock load permissible)				
Approvals and standards								
IEC 60947 EN 60947								

* Except for types with Torx screws



 Kraus & Naimer

www.krausnaimer.com

© Kraus & Naimer, May 2024